

Article number: 20343650M12100KS

Description: E+G levelling foot  
GN 343.6-50-M12-100-KS

## Measures

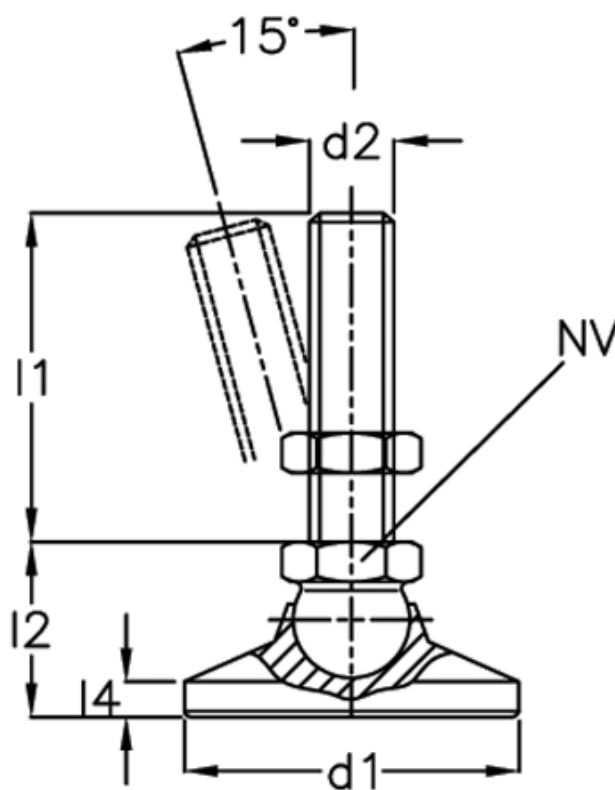

A/F	= 17
d1	= 50
d2	= 12
l1	= 100
l2	= -
l4	= -
Static load (N)	= 16
Weight in (g)	= 275